

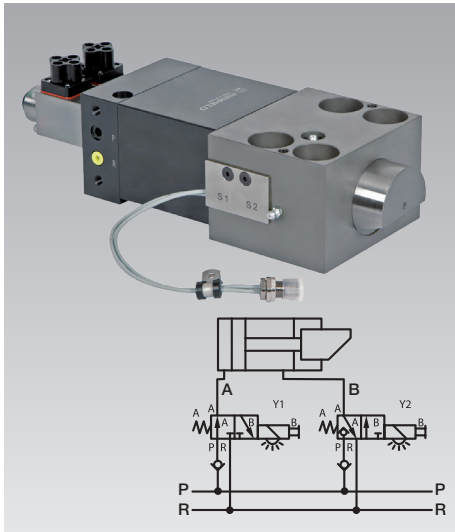

Wedge Clamps for Tapered Clamping Edge
double acting, max. clamping force 100 to 630 kN,
with single valve control for individual control



Advantages

- Safe clamping of moulds/dies with tapered clamping edge
- Each element can be individually controlled
- Single moulds/dies can be clamped
- High operational safety by position monitoring, check valves and automatic motion sequence
- Very sturdy design
- Long service life
- Little installation work as a result of a plug-type closed hydraulic circuit
- Suitable for BUS systems

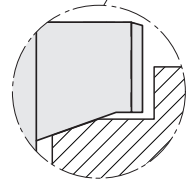
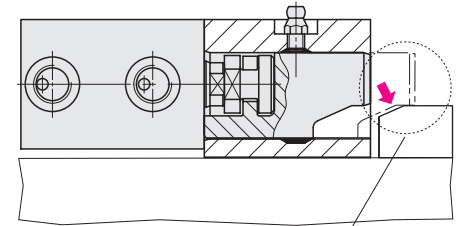
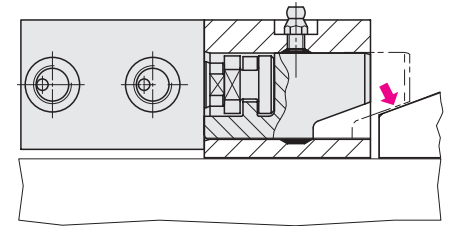

Optionally with safety step

Application

Double-acting wedge clamp with manifold-mounted directional control valves as control valves for the separate control of all clamping elements. For clamping moulds or dies on a press bed or ram or in injection moulding machines, machines and installations.

Technical data

Temperature resistance	[°C]	max. 100
Clamping forces	[kN]	100 – 630
Operating pressure	[bar]	200 – 350
Valve voltage		24 V DC

Dimensions, interfaces and further technical details in the course of the project.

Description

The wedge clamp consists of a hydraulic block cylinder and a piston guided in a housing. The clamping bolt is provided with 20° bevel to clamp on the tapered clamping surface of the mould/die.

Based on the internal design of the wedge clamp and the 20° bevel of the clamping bolt, the system is providing internal friction.

With safety step on request

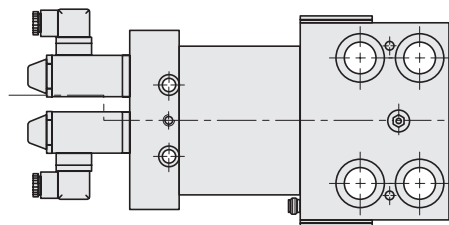

Application examples

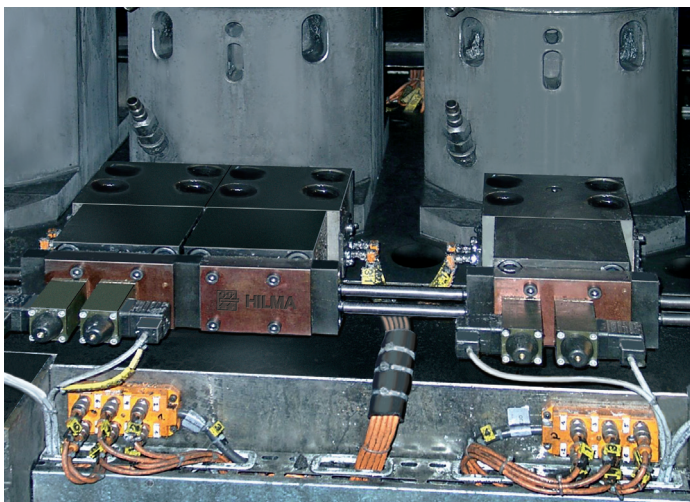

Wedge clamps with directly manifold-mounted directional control valves

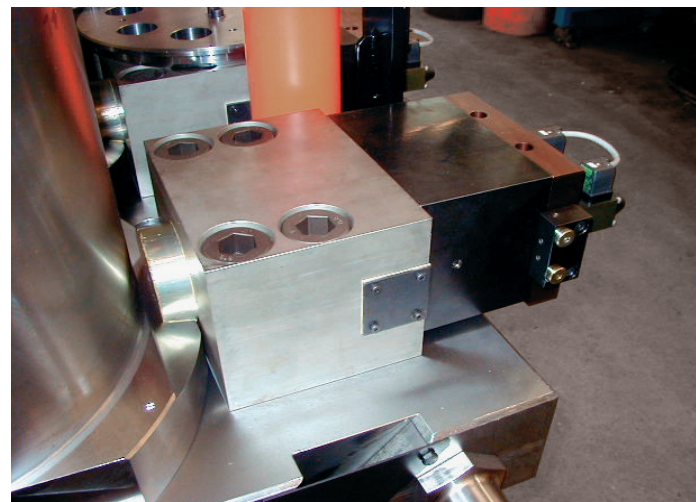

Wedge clamps on a forging press